

**FELCO 31 - Green**

Pruning shear - Good performance - Anvil model

Made in Switzerland by FELCO

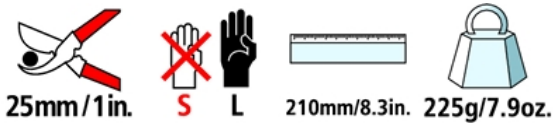

- > **Reliable:** comfortable, light, sturdy handles made of forged aluminium with a lifetime guarantee\* / blade made of high-quality hardened steel and screw-mounted adjustable brass anvil / clean, precise cut / all parts can be replaced
- > **Efficient:** easy cutting adjustment
- > **Ergonomic:** hand protection is provided by the ideal shape of the handles / non-slip coating

## RECOMMENDED FOR

Our recommendation (★ = Recommended, ★★ = Strongly recommended, ★★★ = Best fit)

Viticulture	★ ★ ★
Arboriculture	★ ★ ★
Horticulture	★ ★ ★
Parks and Gardens	★ ★ ★
Nursery	★ ★ ★
Small hand	★ ★ ★
Average-sized hand	★ ★ ★
Large hand	★ ★ ★
Right-handed	★ ★ ★
Left-handed	★ ★ ★

## THE POINTS OF EXCELLENCE



### Forged aluminum handles

Lightweight, strong and sturdy thanks to special aluminum alloys and advanced precision forging methods. Equipment comes with a lifetime guarantee\*.

## ACCESSORIES



FELCO 902  
Sharpening tool  
Sharpening stone



FELCO 903  
Sharpening tool  
Sharpener



FELCO 910  
Holster  
Leather - With belt loop and clip



FELCO 912  
Holster  
Leather - With belt clip



FELCO 980  
Maintenance product  
Spray







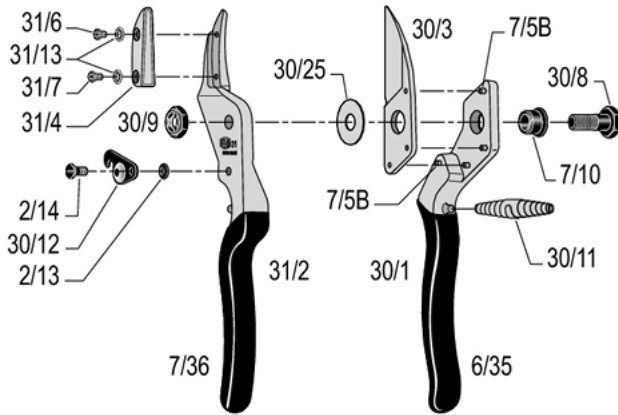

















FELCO 990  
Maintenance product  
Grease

### SPARE PARTS



FELCO	REF.	Designation	Composition	UCC Barcode
	30/3	Blade with washer	1x 30/3 + 1x 30/25	7 83929 40030 3
	31/4	Anvil with screws	1x 31/4 + 1x 31/6 + 1x 31/7 + 2x 31/13	7 83929 40097 6
	30/90	Kit	1x 30/8 + 1x 30/9 + 1x 30/25	7 83929 40032 7
	30/91	Kit	2x 30/11	7 83929 40033 4
	30/92	Kit	1x 2/13 + 1x 30/12 + 1x 2/14	7 83929 40034 1
	30/1	Handle without blade	1x 30/1 + 4x 7/5B + 1x 7/10 + 1x 6/35	7 83929 40191 1
	31/2	Handle without anvil	1x 31/2 + 1x 2/13 + 1x 30/12 + 1x 2/14 + 1x 7/36	7 83929 40200 0
	6/35	Coating for blade handle	1x 6/35	7 83929 40219 2
	7/36	Coating for anvil-blade / anvil handle	1x 7/36	7 83929 40239 0

	7/5B	Rivet for blade	1x 7/5B	 7 83929 40240 6
	31/6	Screw for anvil 6 mm	1x 31/6	 7 83929 40352 6
	31/7	Screw for anvil 8 mm	1x 31/7	 7 83929 40354 0
	30/8	Bolt	1x 30/8	 7 83929 40198 0
	30/9	Nut	1x 30/9	 7 83929 40199 7
	7/10	Bush	1x 7/10	 7 83929 40235 2
	30/25	Washer	1x 30/25	 7 83929 40195 9
	30/11	White spring	1x 30/11	 7 83929 40192 8
	30/12	Thumb catch	1x 30/12	 7 83929 40193 5
	2/13	Spring for thumb catch	1x 2/13	 7 83929 40154 6
	2/14	Screw for thumb catch	1x 2/14	 7 83929 40155 3

## MAINTENANCE



### Cleaning

It is advisable to clean your tool after each use.

If your tool is particularly dirty or subject to rusting after exposure to moisture, do not delay cleaning.



### Oiling

After cleaning, it is advisable to oil the tool so as to protect it from corrosion. The oil will also unjam the tool.



### Sharpening

It is advisable to sharpen your tool at least once a day, but if you feel that your tool is not cutting as well as usual, sharpen it right away!



### Dismantling

It is advisable to dismantle your tool on a regular basis, but at the very latest when it appears to be jammed.

## PARTS REPLACEMENT



### Changing the blade

When the blade and the anvil-blade no longer cross, or when the blade is badly damaged, it is advisable to change it.

Regulate the working of the blade and anvil-blade by adjusting the tightening of the nut. The blade should rub against the anvil-blade over 2/3 of its length.



### Changing the thumb catch

When the thumb catch is damaged and loosens when used, even when the screw is readjusted, change it.



### Changing the plastic coatings for handles

If the coatings are badly damaged, you can replace them.

Soak the coatings for 2 minutes in boiling water - recommended glue: Loctite 415.